

H - Bridge

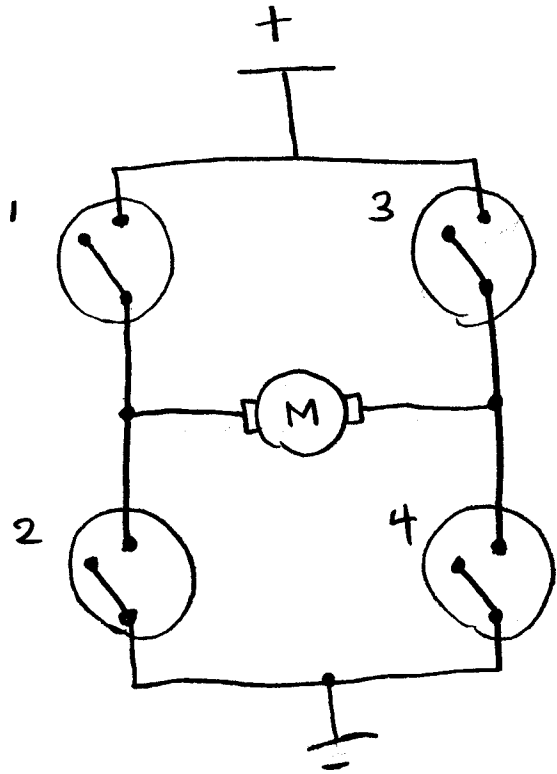

1, 4 on
2, 3 off



2, 3 on
1, 4 off

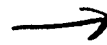

switch types
relays
⇒ transistors

PWM input

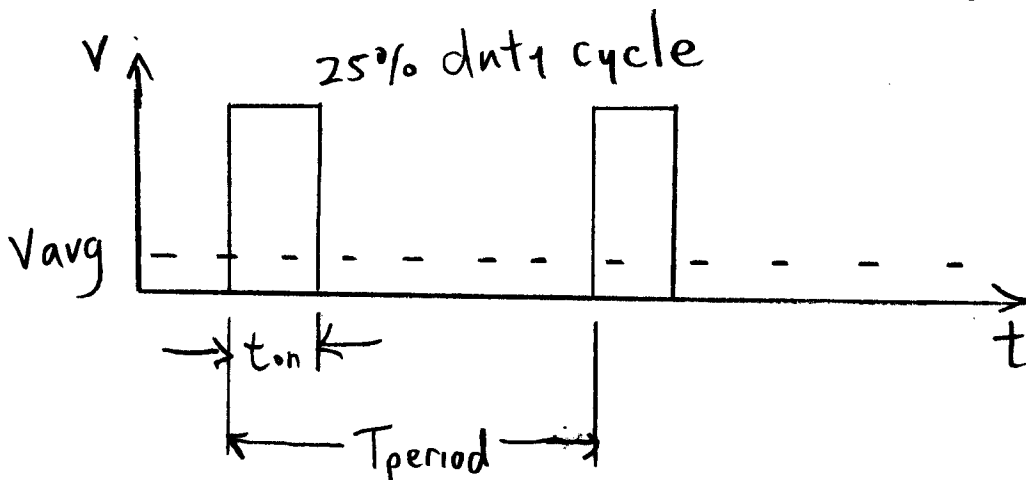
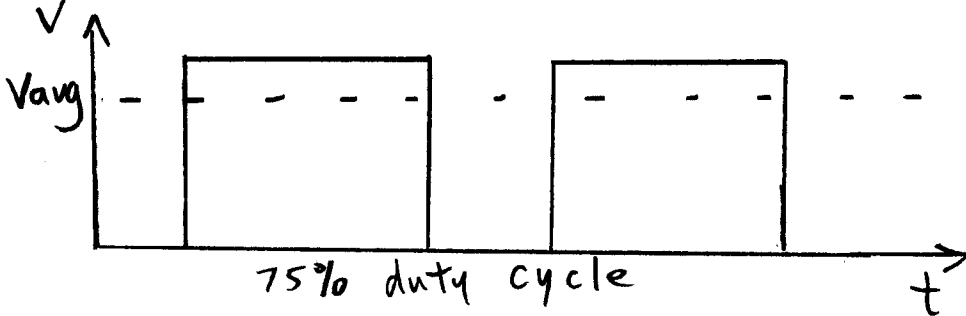

Inductive Load Switching

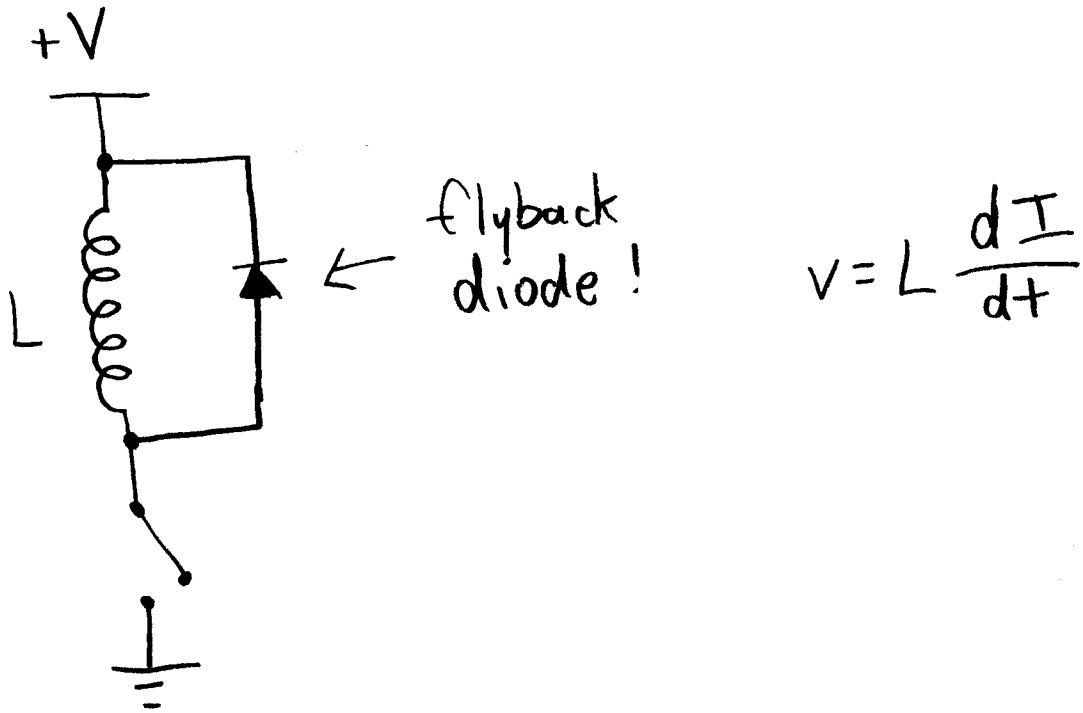

H-Bridge MOSFET implementation

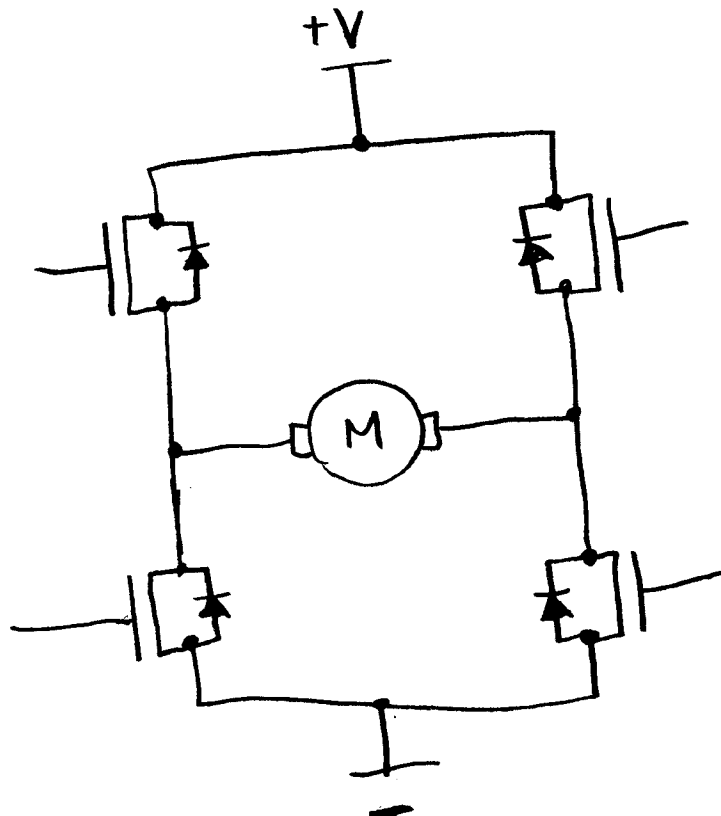

Servo (Hobby)

~ 5 V operation

stall ~ 1 A

PWM control

1-2 ms per 20 ms

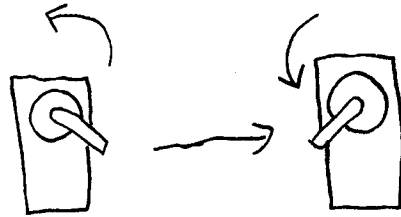

1 end → other end

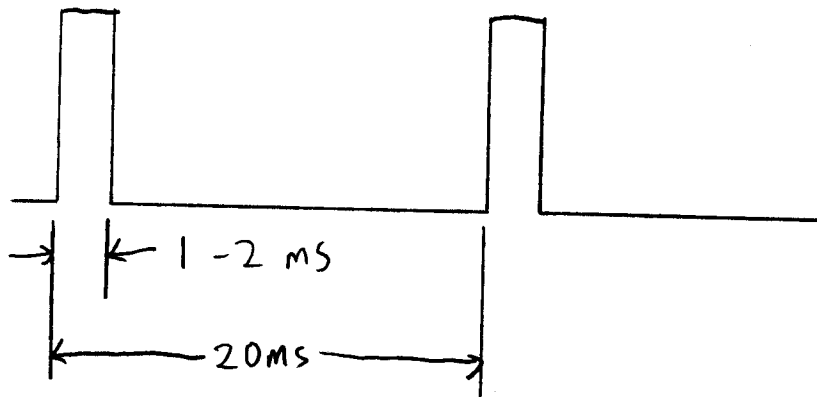

⇒ position determined by internal rotary potentiometer

Encoders

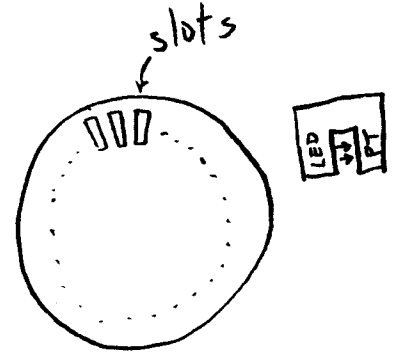
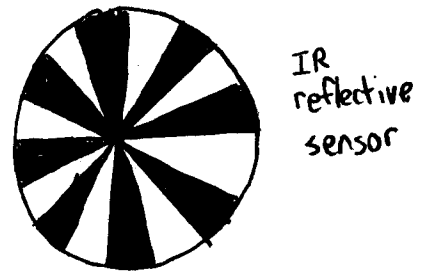
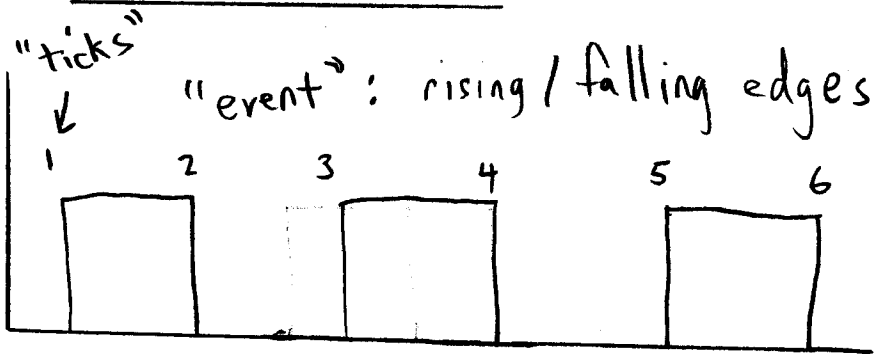

QUADRATURE ENCODER

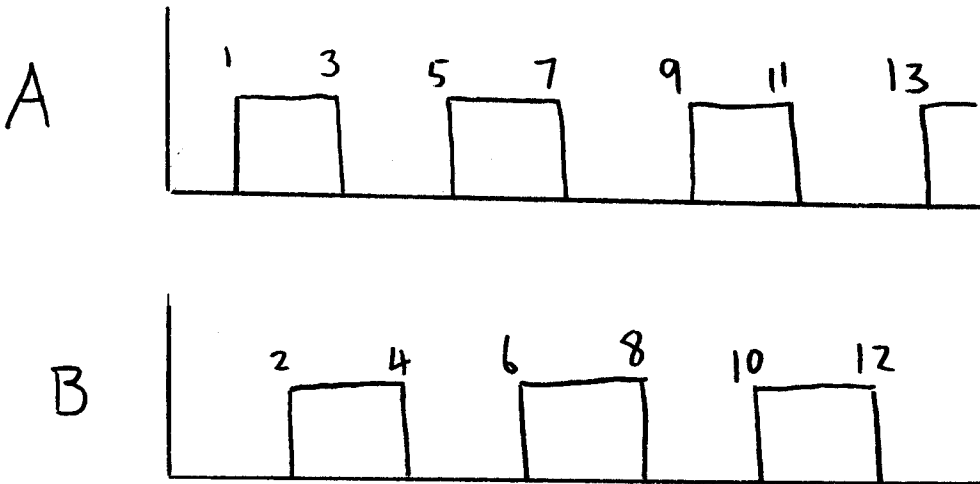

90° out of phase

Forward

A	B
0	0
1	0
1	1
0	1
0	0

Backward

A	B
1	0
0	0
0	1
1	1
1	0

Encoders (Continued...)

Encoder w/ index ← channel that pulses once per revolution

ABSOLUTE ENCODER

- has coded disk
- outputs absolute angular position
- # of channels → resolution
- output via parallel or serial interface

Figure 1 Gray Code

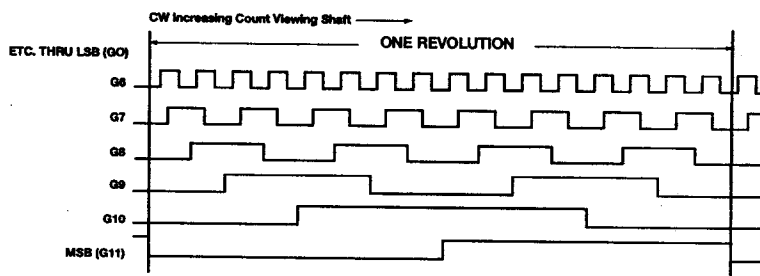
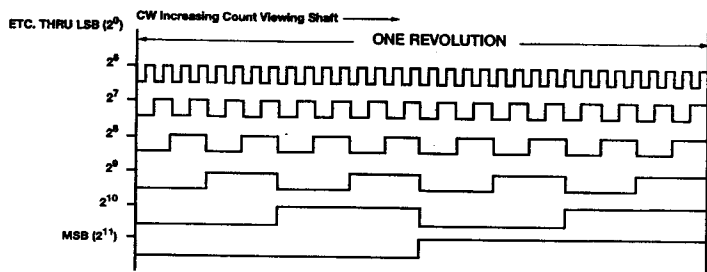

Figure 2 Natural Binary



Power Considerations

? Isolate Controller to its own power source

? External Drive Motor Power

? External Servo Power

? External sensor Power

⇒ Use of 5v regulator may be required for some sensors